

AMERICAN STRATOCASTER® HH, 0117100, R/W

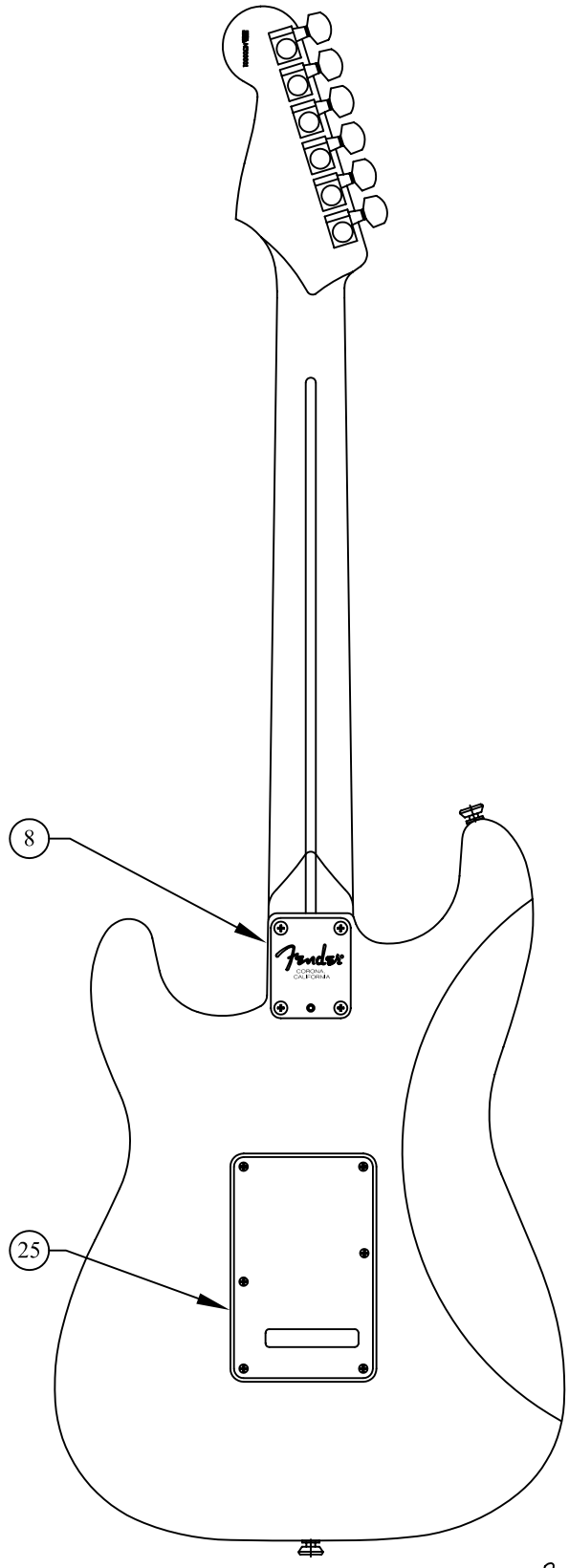
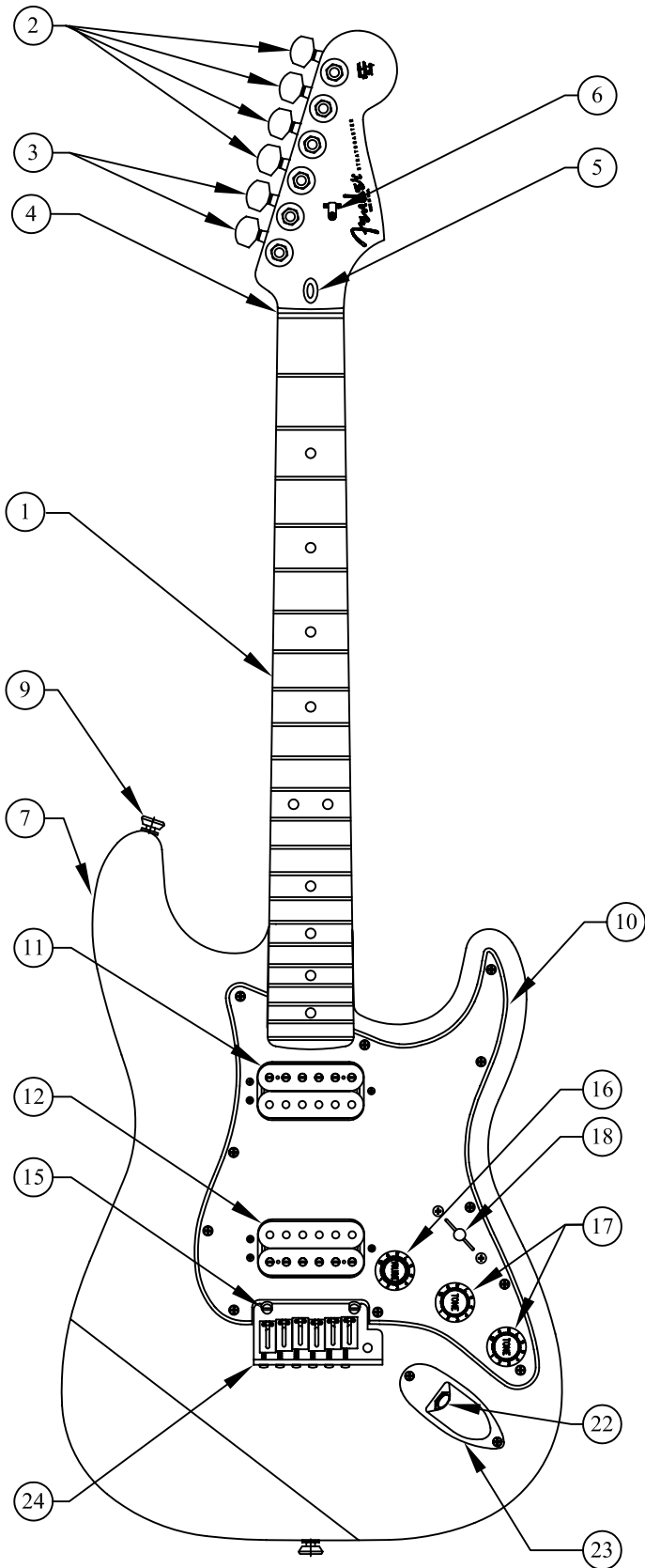

*Fender*<sup>®</sup>

# AMERICAN STRATOCASTER® HH, 0117100, R/W

## WIRING DIAGRAM

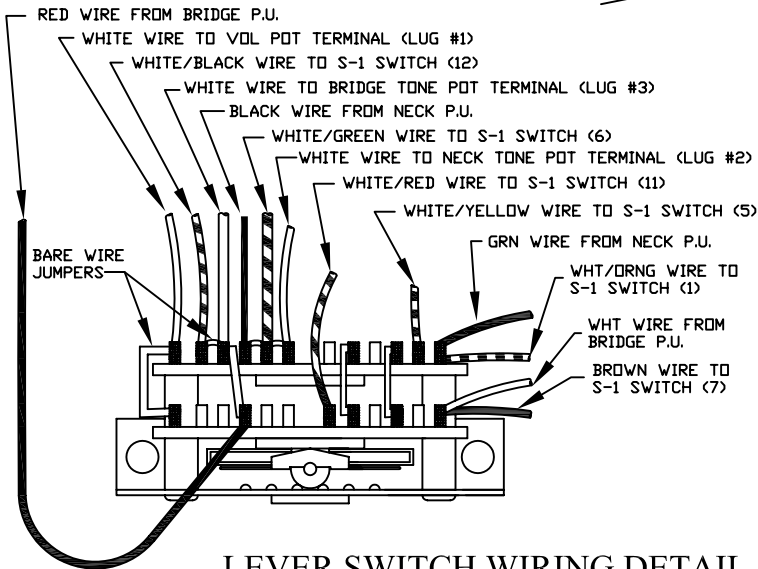
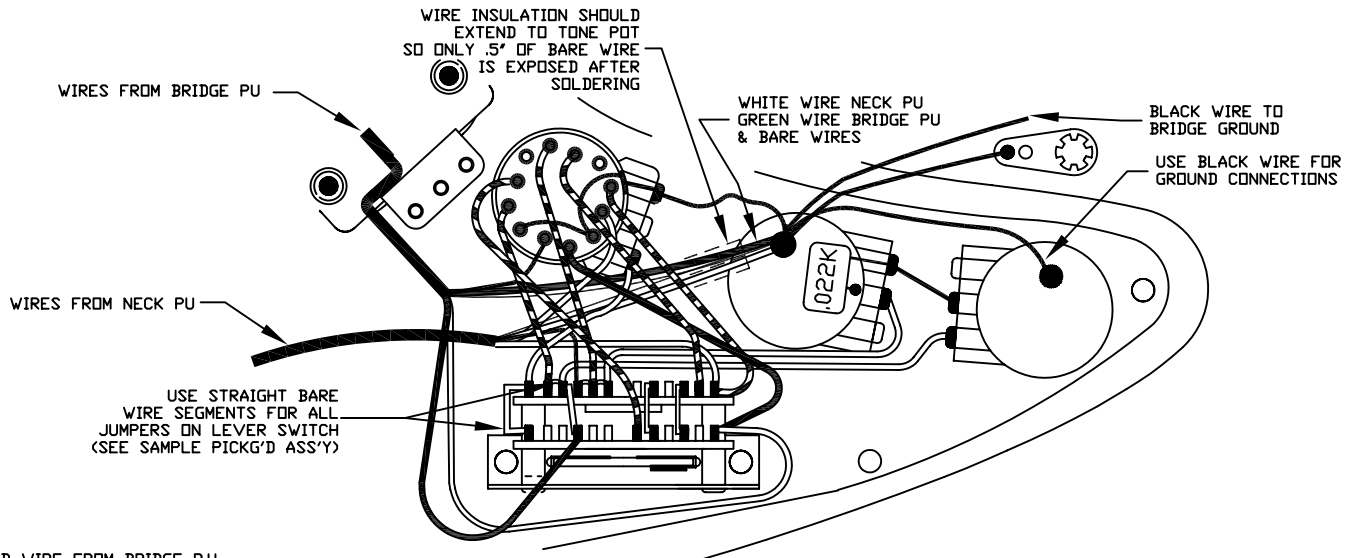
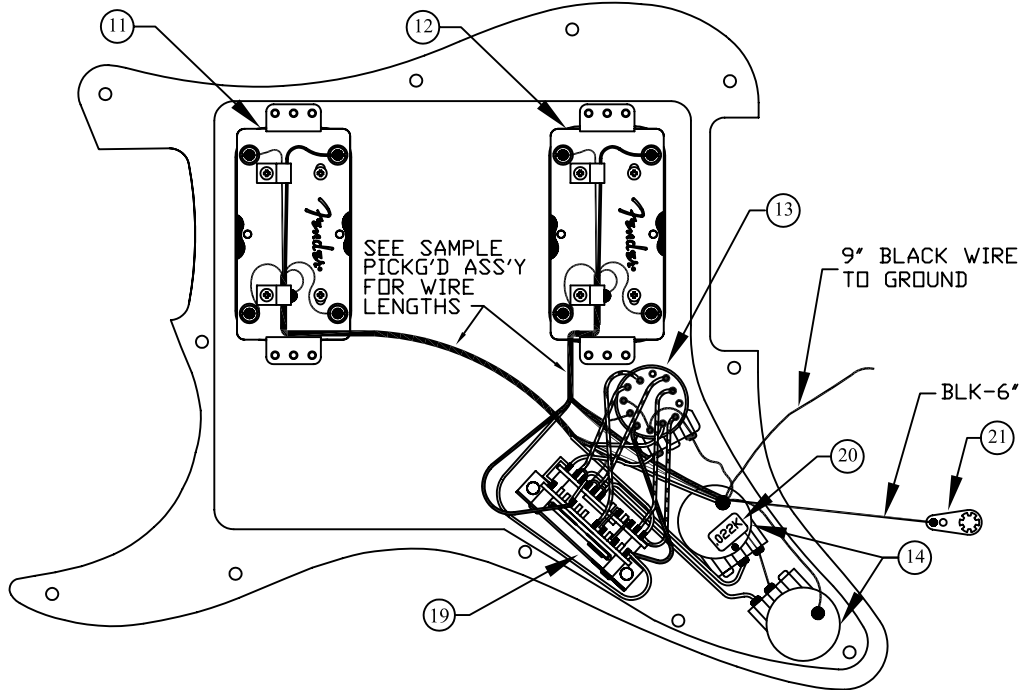

LEVER SWITCH WIRING DETAIL

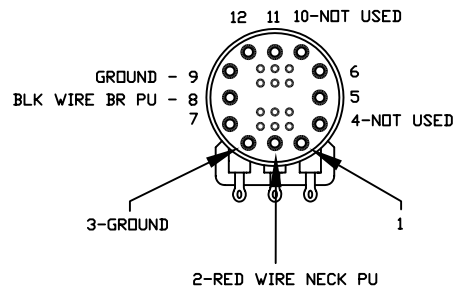

S-1 SWITCH WIRING DETAIL

# AMERICAN STRATOCASTER® HH, 0117100, R/W

REF.#	P/N	DESCRIPTION	REF.#	P/N	DESCRIPTION
1	0056215000	Neck, American Stratocaster®, RW	24	0026095000	Bridge Assembly
2	0056260000	Tuning Key, (E,B,G,D) Std Schl		0013265000	Tremolo Arm
	0058815000	Washer Schalr		0010272100	Tremolo Claw
	0058820000	Bushing Schalr		0018671000	Tremolo Spring
3	0021374000	Tuning Key, XGS-1C Std Schl		0015636000	Tremolo Claw Mounting Screw
	0058815000	Washer Schalr		0026097000	Bridge Plate
	0058820000	Bushing Schalr		0026099000	Bridge Section
4	0083675000	Bone Nut		0017031000	Intonation Screw, (6)
5	0023811000	Truss Rod Adjusting Wrench		0019395000	Intonation Spring, (5&6)
6	0021537000	String Guide		0019394000	Intonation Spring, (1-4)
	0021405000	Mounting Screw	0026779000	Height Adjustment Screw, (1&6)	
7	See Chart	Body Stratocaster®	0026780000	Height Adjustment Screw, (2-5)	
8	0054038000	Neck Mounting Plate	0026098000	Bridge Block	
	0021424000	Mounting Screw	25	0038492000	Back Plate AM Series Stratocaster®
	0031571000	Tilt Adjustment Screw		0021407000	Mounting Screw
	0023811000	Tilt Adjusting Wrench			
9	0063267000	Strap Button			
	0016188000	Mounting Screw			
	0019056000	Felt Washer, Black			
10	0055268000	Pickguard, B/W/B			
	0021407000	Mounting Screw			
11	0065290000	Pickup, Neck			
	0050167000	Spring			
	0050166000	Screw			
12	0063274000	Pickup, Bridge			
	0050167000	Spring			
	0050166000	Screw			
13	0061257000	Switch Pot Assembly 500K, Volume			
	0016352000	Mounting Nut			
	0016436000	Lock Washer			
14	0038950000	Control 500K			
	0016352000	Mounting Nut			
	0016436000	Lock Washer			
15	0028957000	Pivot Screw			
	0028958000	Insert			
16	0059267020	Knob, Volume Black			
	0059266020	Cap, Volume Black			
17	0056146000	Knob, Tone Black			
18	0013267000	Knob, Selector Switch Black			
19	0050610000	Switch, 5-Position, 4 Pole			
	0021417000	Mounting Screw			
20	0024832000	Capacitor, .022uF			
21	0012869000	Solder Lug			
	0015116000	Mounting Screw			
22	0021956000	Output Jack			
	0016436000	Lock Washer			
	0016352000	Mounting Hex Nut			
23	0010280090	Jack Ferrule			
	0021407000	Mounting Screw			

## BODY COMBINATION CHART

BODY	
P/N	Color
0056229506	Black
0056229525	Chrome Red
0056229591	Chrome Silver
0056229595	Chrome Blue

# AMERICAN STRATOCASTER® HH, 0117100, R/W

## SWITCH & CONTROL FUNCTION

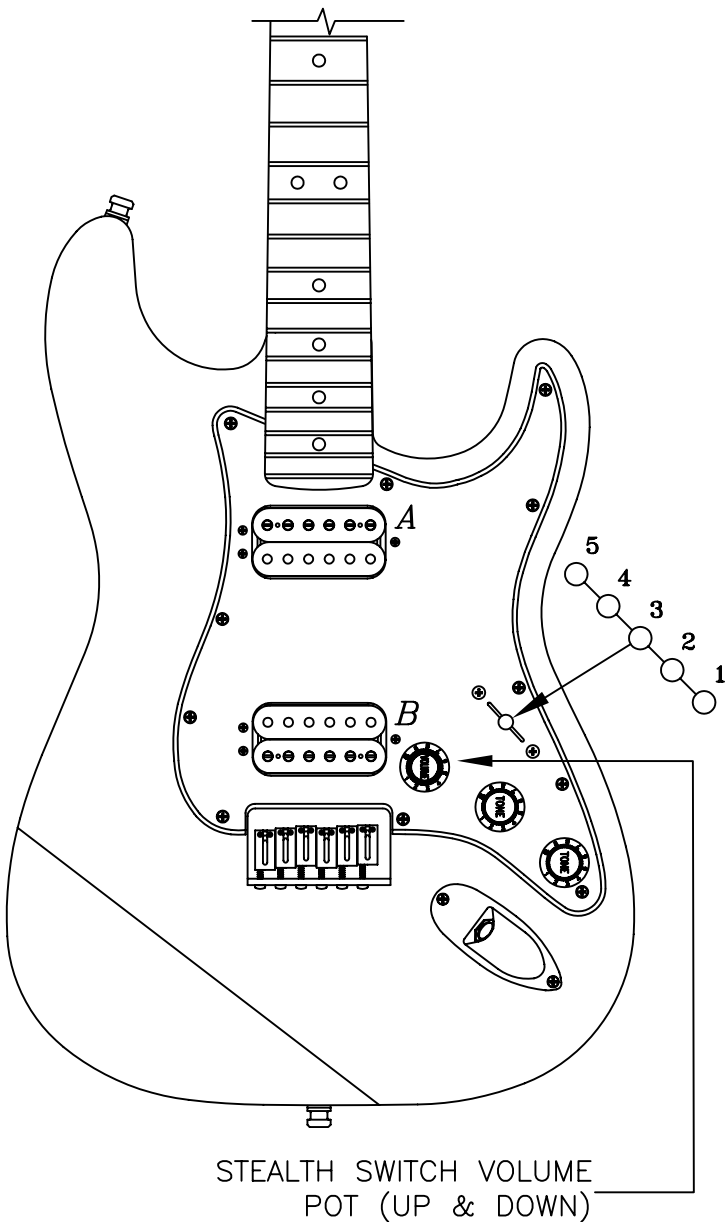

5 WAY SW POSITIONS, STEALTH SW UP					
5	4	3	2	1	POSITION
MV NT	MV NT	MV NT+BT	MV BT	MV BT	CONTROL
					← NECK PICKUP (A)
SER	INS	SER			
					← BRIDGE PICKUP (B)
		SER	INS	SER	

5 WAY SW POSITIONS, STEALTH SW DOWN					
5	4	3	2	1	POSITION
MV NT	MV NT	MV NT+BT	MV BT	MV BT	CONTROL
					← NECK PICKUP (A)
PAR					
					← BRIDGE PICKUP (B)
				PAR	

MV = MASTER VOLUME  
 NT = NECK TONE  
 BT = MID/BRIDGE TONE  
 SER = COIL PAIR IN SERIES  
 PAR = COIL PAIR IN PARALLEL  
 INS = INSIDE COILS IN PARALLEL,  
 SERIES WITH OUTSIDE COIL

	PICKUP IS ON
	PICKUP IS OFF
<i>A</i>	PICKUP (NECK)
<i>B</i>	PICKUP (MIDDLE)

INDICATES POSITION OF 5 WAY SWITCH