

PICKUP CONFIGURATION

NECK	POLEPIECE TYPE	MAGNETIC POLE
	SLAG	NORTH
	MINUS	SOUTH
	HEX	NORTH
	HEX	SOUTH

COIL SELECTING CONFIGURATION

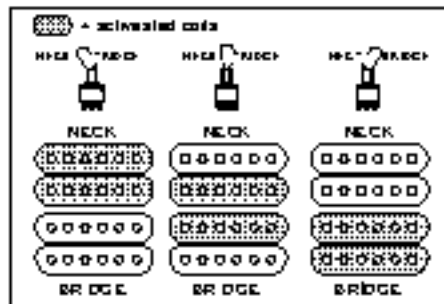

NECK  
DIMARZIO  
Air Norton  
(DP193)

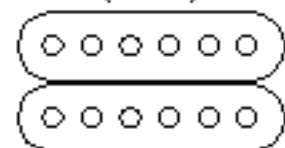

RED  
BLACK

WHITE  
GREEN  
DRAIN

BRIDGE  
DIMARZIO  
Stieves Special  
(DP161)

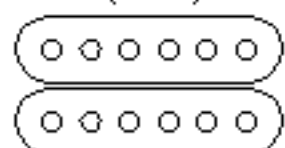

RED  
BLACK

WHITE  
GREEN  
DRAIN

BRIDGE MIDDLE NECK

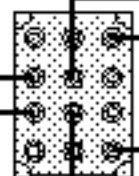
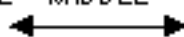

To Bridge GROUND

VOLUME  
500Kohm  $\ominus$

STONE  
500Kohm  $\ominus$

223

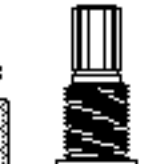

OUTPUT

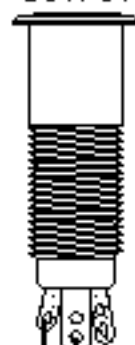

MODEL NUMBER	MODEL NAME	APPROVED BY	CHECKED BY	DRAWING BY	SCALE
SP3'D	'96 JPM100			A. M.	
HOSHINO GAKKICO., LTD. No. 22, 3-CHOME, SHUNOKU-CHO, NAGASHIKU, NAGOYA, JAPAN		DRAWING NUMBER		DATE	SIZE
		W/96035		'95/07/24	A4